

Description

High-precision pressure and vacuum switch with electrical outlet signal. The microswitch satisfies UL and CSA regulations. Polysulphone of the body approved by National Sanitation Foundation. The switch also complies with FDA regulations and is suitable for water and food products.

Media Switch contact Contact load

compressed air, non-corrosive gases or liquids
micro SPDT switch, covered by plastic cap
3 A at 230 V AC or 1.2 A at 125 V DC
10 A at 230 V AC or 0.5 A at 125 V DC

Electrical connector

0.187" (4.75 mm) quick connector for Molex connector

Repeatability

± 2% FS

Certifications

CSA-certified and UL-listed

Switching time

25 ms

Mounting position

any

Temperature range

4 °C to 66 °C / 40 °F to 150 °F

Material

Body: polysulphone Spring: stainless steel
Diaphragm: polyurethane Media non-contact parts: nylon, carbon fibre nylon, acetal

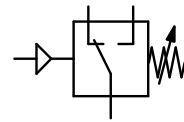

3 ... 30 mbar / 7 bar
-1 ... -10 mbar / -1 bar

Description

Contact load	Hysteresis typical	Hysteresis max.	Over-pressure max. bar	Measurement range bar	Order number
max. A	mbar	mbar	max. bar	bar	



Pressure and Vacuum Switch

pressure port 1/8" NPT male with nylon nipple
Ø 1/16", and covering cap, SPDT switch

F4200

pressure switch	3	3	10	1	0.003 ... 0.03	F4200- 0,5PT
	10	7	20	2	0.014 ... 0.14	F4200- 2PT
	10	30	50	2	0.035 ... 0.35	F4200- 5PT
	10	70	110	3	0.035 ... 1.0	F4200- 15PT
	10	120	160	4	0.035 ... 2.1	F4200- 30PT
	10	240	350	8	0.035 ... 4.2	F4200- 60PT
vacuum switch	10	400	500	8	0.070 ... 7.0	F4200-100PT
	3	1	3	-0.3	-0.001 ... -0.01	F4200-X 4PT
	10	17	27	-1	-0.007 ... -0.17	F4200-X 5PT
	10	34	50	-1	-0.015 ... -0.34	F4200-X10PT
	10	68	100	-1	-0.050 ... -1.00	F4200-X30PT

Special options, add or change the appropriate letter

flush mounting

barbed fitting made of nylon, Ø 1/16", Ø 2 mm

F4200- ... FM

panel mounting

barbed fitting made of nylon, Ø 1/16", Ø 2 mm

F4200- ... PM

manifold mounting

F4200- ... MM

barbed fittings

for FM and PM, made of nylon, Ø 1/16", Ø 2 mm
nylon, Ø 1/8", Ø 4 mm
polysulphone, Ø 1/16", Ø 2 mm
polysulphone, Ø 1/8", Ø 4 mm

F4200- ... B80 Stand.

F4200- ... B85

F4200- ... P80

F4200- ... P85

F4200- ... 1B

gold contact

F4200- ... X

factory-set switchpoint

± 5%, indicate on order

F4200- ... L

free of oil and grease

specially cleaned, suitable for oxygen



F4200-...PT



F4200-...FM



F4200-...PM



F4200-...MM

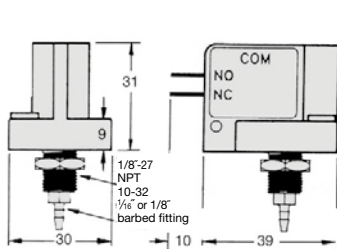

F4200 - PM

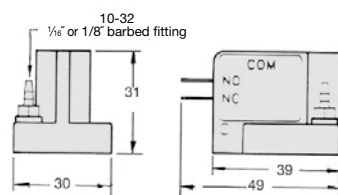

F4200 - FM

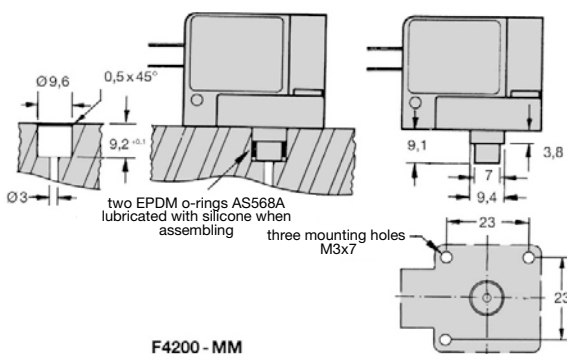

F4200 - MM

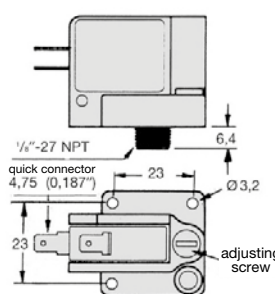

F4200 - PT

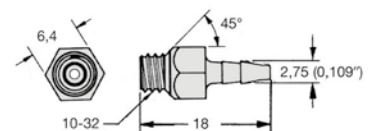

B80 / P80

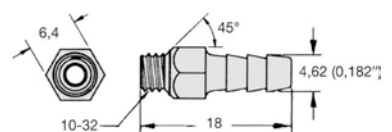

B85 / P85

* Product group

PDF CAD
www.aircom.net



Order example:
F4200-0,5PT